

STABILITY ANALYSIS OF A LINEAR SYSTEM HAVING DIFFERENT TYPES OF NON-LINEARITIES BY PHASE PLANE TECHNIQUE USING MATLAB

Ambreen Siddiqui, Fatima Yasmeen

Electrical & Electronics dept, Integral University
Integral University, Lucknow, India

Abstract—The purpose of this work is to investigate the stability of a non linear system. There are several methods of analyzing the stability of a non linear system, out of which phase plane technique has been used in this work. For different linear system some non linearity has been introduced and the result has been taken. This analysis results in stable or unstable system of the considered non linear system for different type of non linearity.

Keywords-non linearity,,phase plane technique,transfer function,phase portrait.

I. INTRODUCTION

The non linear system does not possess the homogeneity and superposition properties. The stability of the non linear system depends on the input and initial state of the system. Analysis of the non linear system implies the study of behavior of the system when there is a change in the system variables from operating and equivalent point. All practical systems are non linear upto some extent, which makes the analysis of non linear systems imperative for a control engineer. In case of non linear system, the differential equation is non linear, which requires a great deal of mathematical labour in calculating the transient response. To overcome these difficulties, a dedicated graphical method of analysis is required for the non linear system. Phase plane analysis is the method which serves the above state purpose using “*Nelinsys Toolbox*” in Matlab. Phase plane method is a time domain technique since time is the independent variable for it. Stability analysis of a non linear system is actually the stability analysis about a singular point.

II. PRESENT WORK

Consideration and assumption

Considering different types of system having different types of non linearities such as Ideal relay, Ideal relay with dead zone, Ideal relay with hysteresis and saturation. All these systems are described by its block diagram.

Different types of non linearities or discontinuities are as follows. The analysis is based on such non linearities thus the observation results in stable or unstable focus of the system.

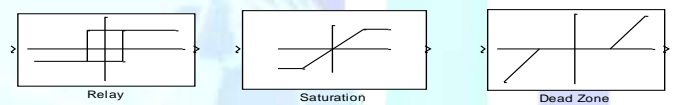

Fig1 : Types of non linearities

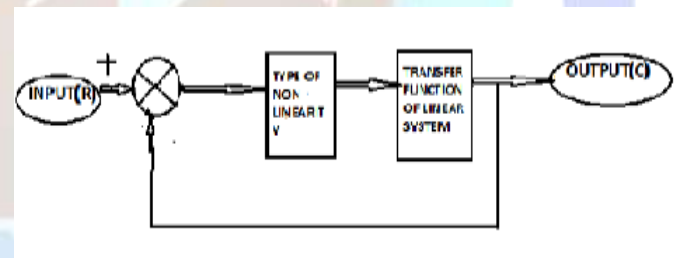

Fig2 : Block Diagram of linear system with non linearity

CASE1:

Transfer function of linear part :

$$G(s) = \frac{1}{s^2 + s + 1}$$

Non linearity : Saturation [-1 -4 1 4]

CASE2:

Transfer function of linear part :

$$G(s) = \frac{1}{s^2 + s + 1}$$

Non linearity : Ideal relay[1 -1]

CASE3:

Transfer function of linear part :

$$G(s) = \frac{1}{s^2 + 0.5s}$$

Non linearity : Ideal relay [1 -1]

CASE4:

Transfer function of linear part :

$$G(s) = \frac{1}{s^2}$$

Non linearity : Ideal relay [2 -2]

CASE5 :

Transfer function of linear part :

$$G(s) = \frac{1}{s^2 + 2s - 3}$$

Non linearity :Relay with hysteresis[-1 -4 1 4]

CASE6 :

Transfer function of linear part :

$$G(s) = \frac{1}{s^2 + 2s - 3}$$

Non linearity :Saturation [-1 -4 1 4]

CASE7 :

Transfer function of linear part :

$$G(s) = \frac{1}{s^2 + 2s - 3}$$

Non linearity :Relay with dead zone [-1 -1 1 1]

CASE8 :

Transfer function of linear part :

$$G(s) = \frac{1}{s^2 + 2s - 3}$$

Non linearity :Ideal relay [-1 1]

Procedure for determinig stability

- a) The analysis of the non linear system has been done by using MATLAB.
- b) Nelinsys Toolbox consists of analysis and synthesis block of non linear system.
- c) From analysis block “Phase Portrait of 2nd order loop with hard non linearity” has been extracted to the model file and “Vector XY graph” has also been taken. .and then connected as shown in figure 2.
- d) Both blocks are right clicked in order to enter the given data such as transfer function and type of non linearity with initial conditions .
- e) After this ,run the model or start simulation, thus the phase portrait has been obtained.
- f) From the phase portrait ,the direction of movement of the curve has been recorded which denotes the system stability i.e. stable or not.
- g) If the trajectory is spiral curve converging towards the origin ,then the system is Stable Focus.i.e the roots are complex conjugate with negative real part.
- h) If the trajectory is spiral curve diverging from the origin ,then the system is Unstable Focus.i.e the roots are complex conjugate with positive real part.
- i) If the trajectory is of closed form about the origin ,then the system is Stable Focus .i.e the roots are complex .
- j) If the trajectory is saddle i.e first converging towards origin and without touching it, diverges towards another side, then the system is inherently unstable.i.e. roots are real and negative of each other.

III. ANALYSIS OF CONSIDERED SYSTEM

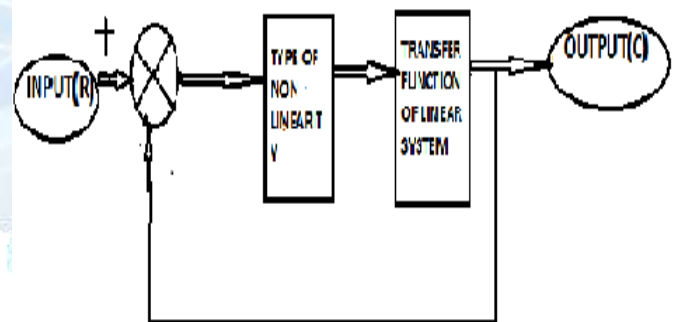

Fig 3 : General block diagram of linear system with non linearity.

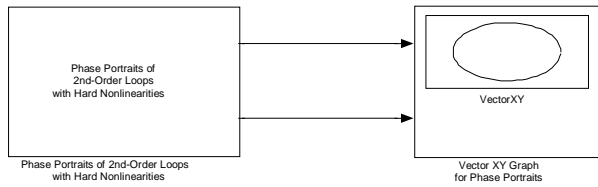

Fig 4 : Matlab block for Non linear system of fig 1

CASE1:

Transfer function of linear part :

$$G(s) = \frac{1}{s^2 + s + 1}$$

Non linearity : Saturation [-1 -4 1 4]

**SOURCE BLOCK PARAMETERS OF CASE1
IN MATLAB SIMULINK**

Initial condition for x1 ranges = -3<x1<3

No of initial conditions for x1=15

Initial conditions for x2 ranges = -5<x2<5

No.of initial conditions for x2 = 3

Vector XY graph ranges for :

X1 = -3 to 3

X2 = -3 to 3

INPUT :

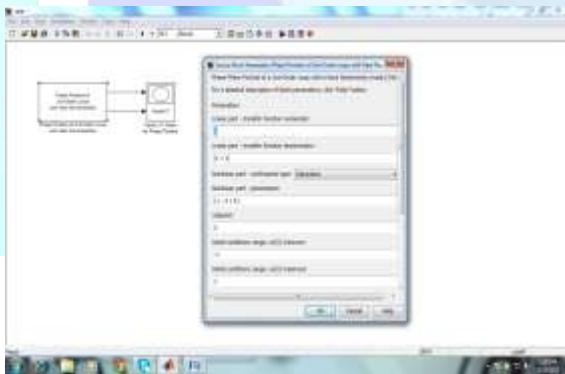

FigA1: MATLAB SIMULINK FOR CASE 1

OUTPUT

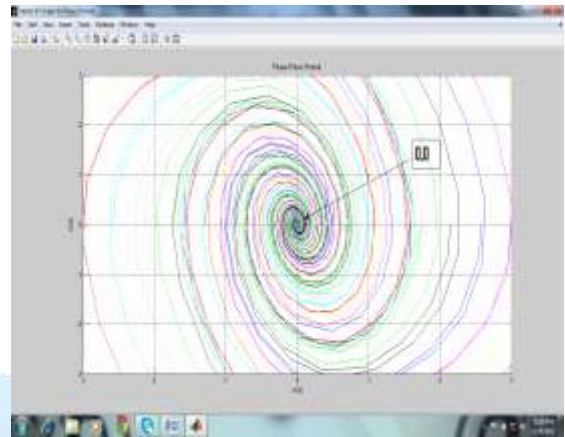

Fig: A2 : PHASE PORTRAIT FOR CASE1

CASE2:

Transfer function of linear part :

$$G(s) = \frac{1}{s^2 + s + 1}$$

Non linearity : Ideal relay[1 -1]

**SOURCE BLOCK PARAMETERS OF CASE2
IN MATLAB SIMULINK**

Initial condition for x1 ranges = -2 <x1< 2

No of initial conditions for x1=10

Initial conditions for x2 ranges = -2 <x2< 5

No.of initial conditions for x2 = 3

Vector XY graph ranges for :

X1 = 0 to 5

X2 = -5 to 5

INPUT :

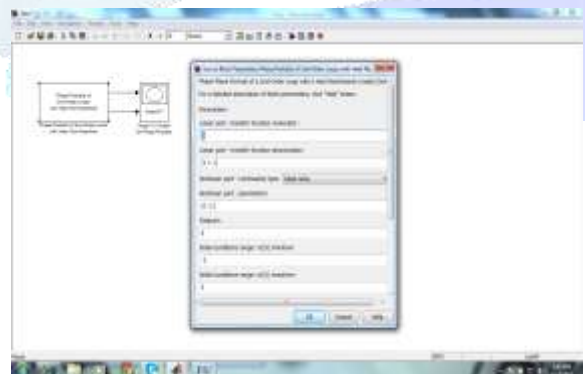

FigB1: MATLAB SIMULINK FOR CASE 2

OUTPUT

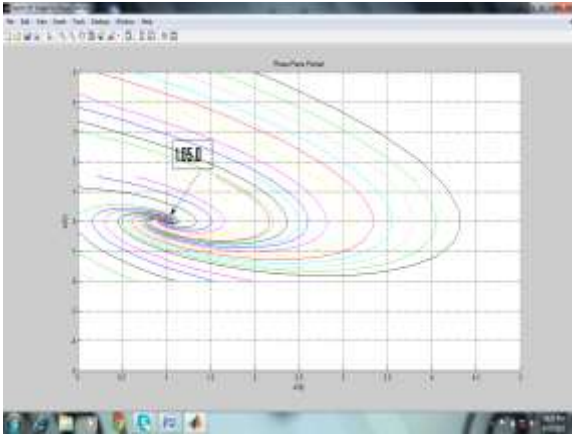

FigB2: PHASE PORTRAIT FOR CASE2

CASE3:

Transfer function of linear part :

$$G(s) = \frac{1}{s^2 + 0.5s}$$

Non linearity : Ideal relay [1 -1]

**SOURCE BLOCK PARAMETERS OF CASE3
IN MATLAB SIMULINK**

Initial condition for x1 ranges = -3 < x1 < 3

No of initial conditions for x1 = 15

Initial conditions for x2 ranges = -3 < x2 < 3

No. of initial conditions for x2 = 10

Vector XY graph ranges for :

X1 = -3 to 3

X2 = -3 to 3

INPUT :

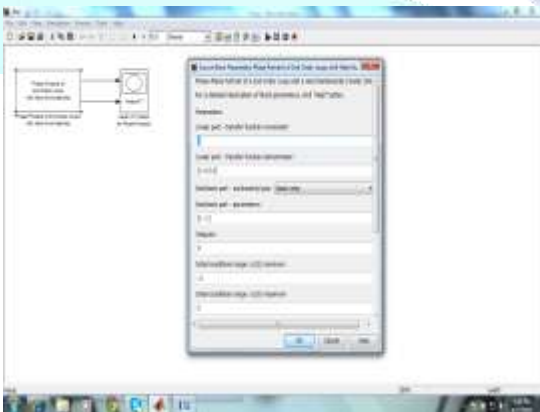

FigC1 : MATLAB SIMULINK FOR CASE 3

OUTPUT :

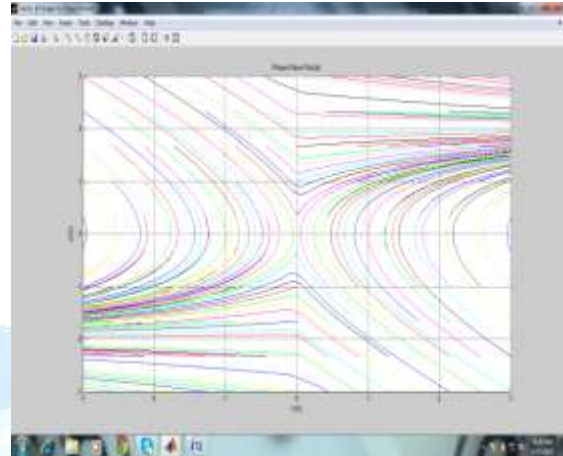

FigC2 : PHASE PORTRAIT FOR CASE3

CASE4:

Transfer function of linear part :

$$G(s) = \frac{1}{s^2}$$

Non linearity : Ideal relay [2 -2]

**SOURCE BLOCK PARAMETERS OF CASE4
IN MATLAB SIMULINK**

Initial condition for x1 ranges = -2 < x1 < 2

No of initial conditions for x1 = 10

Initial conditions for x2 ranges = -2 < x2 < 5

No. of initial conditions for x2 = 3

Vector XY graph ranges for :

X1 = -3 to 3

X2 = -3 to 3

INPUT :

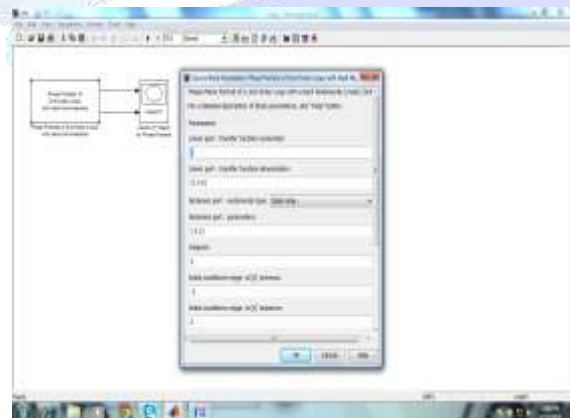

FigD1 : MATLAB SIMULINK FOR CASE 4

OUTPUT :

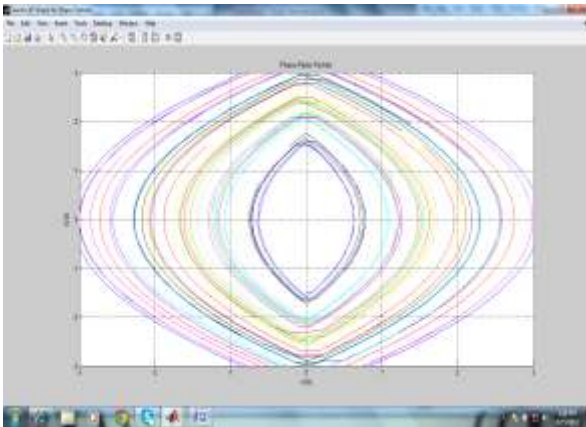

FigD2 : PHASE PORTRAIT FOR CASE4

CASE5 :

Transfer function of linear part :

$$G(s) = \frac{1}{s^2 + 2s - 3}$$

Non linearity :Relay with hysteresis[-1 -4 1 4]

SOURCE BLOCK PARAMETERS OF CASE5

IN MATLAB SIMULINK

Initial condition for x1 ranges = -2 < x1 < 2

No of initial conditions for x1=15

Initial conditions for x2 ranges = -5 < x2 < 5

No.of initial conditions for x2 = 15

Vector XY graph ranges for :

X1 = -2 to2

X2 = -5 to 5

INPUT :

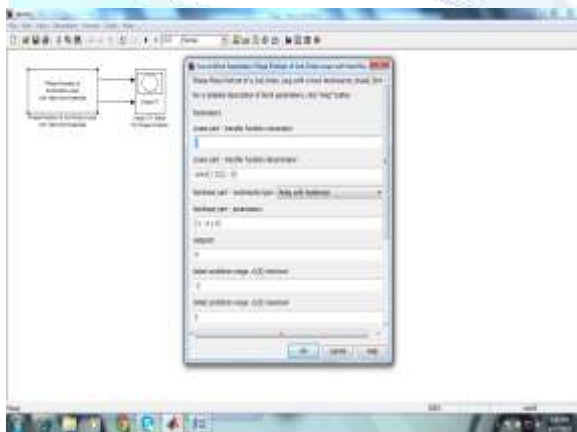

FigE1 : MATLAB SIMULINK FOR CASE

OUTPUT :

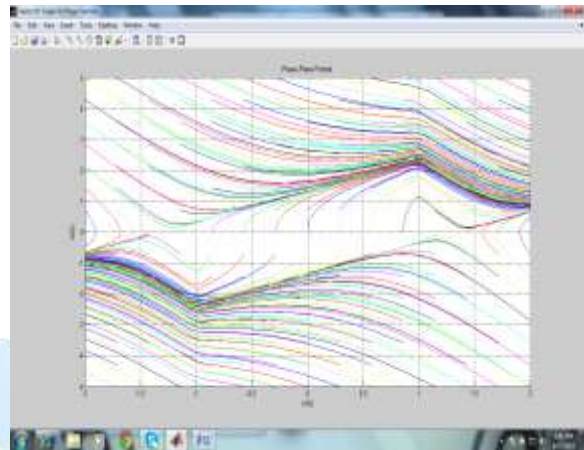

FigE2 :: PHASE PORTRAIT FOR CASE5

CASE6 :

Transfer function of linear part :

$$G(s) = \frac{1}{s^2 + 2s - 3}$$

Non linearity :Saturation [-1 -4 1 4]

SOURCE BLOCK PARAMETERS OF CASE6

IN MATLAB SIMULINK

Initial condition for x1 ranges = -3<x1<3

No of initial conditions for x1=15

Initial conditions for x2 ranges = -5<x2<5

No.of initial conditions for x2 = 3

Vector XY graph ranges for :

X1 = -3 to 3

X2 = -3 to 3

INPUT

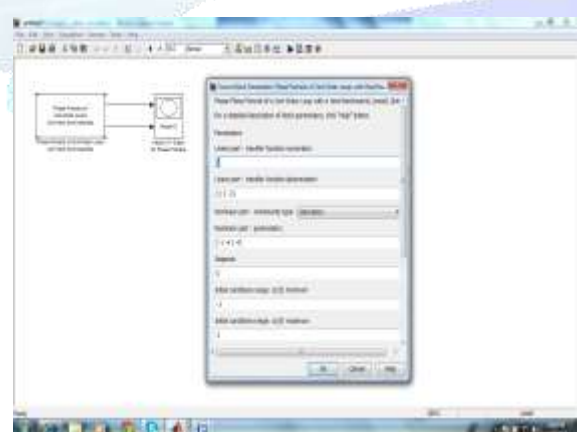

FigF1 :: MATLAB SIMULINK FOR CASE 6

OUTPUT

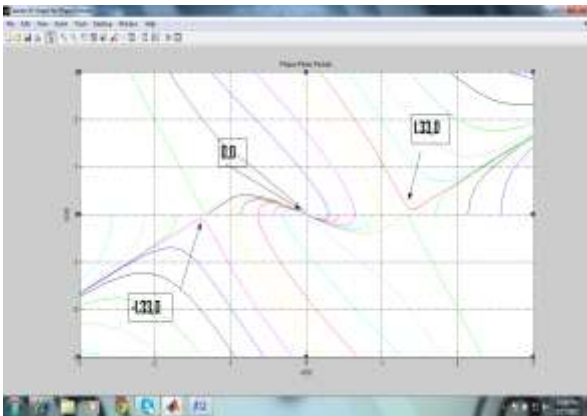

FigF2 : PHASE PORTRAIT FOR CASE6

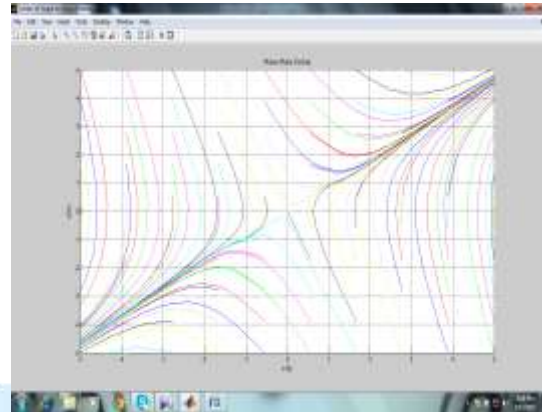

FigG2 : : PHASE PORTRAIT FOR CASE7

CASE7 :

Transfer function of linear part :

$$G(s) = \frac{1}{s^2 + 2s - 3}$$

Non linearity :Relay with dead zone [-1 -1 1 1]

**SOURCE BLOCK PARAMETERS OF CASE7
IN MATLAB SIMULINK**

Initial condition for x1 ranges = -5 < x1 < 5

No of initial conditions for x1=10

Initial conditions for x2 ranges = -5<x2<5

No.of initial conditions for x2 = 10

Vector XY graph ranges for :

X1 = -5 to 5

X2 = -5 to 5

INPUT :



FigG1 : MATLAB SIMULINK FOR CASE 7

OUTPUT

CASE8 :

Transfer function of linear part :

$$G(s) = \frac{1}{s^2 + 2s - 3}$$

Non linearity :Ideal relay [-1 1]

**SOURCE BLOCK PARAMETERS OF CASE8
IN MATLAB SIMULINK**

Initial condition for x1 ranges = -5 < x1 < 5

No of initial conditions for x1=10

Initial conditions for x2 ranges = -5 < x2 < 5

No.of initial conditions for x2 = 10

Vector XY graph ranges for :

X1 = -5 to 5

X2 = -5 to 5

INPUT

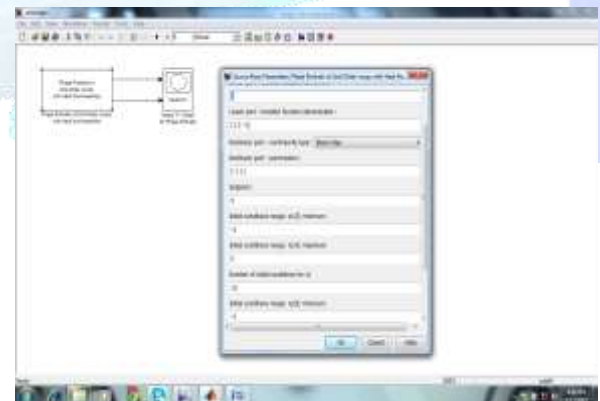

FigH1 : : MATLAB SIMULINK FOR CASE 8

OUTPUT

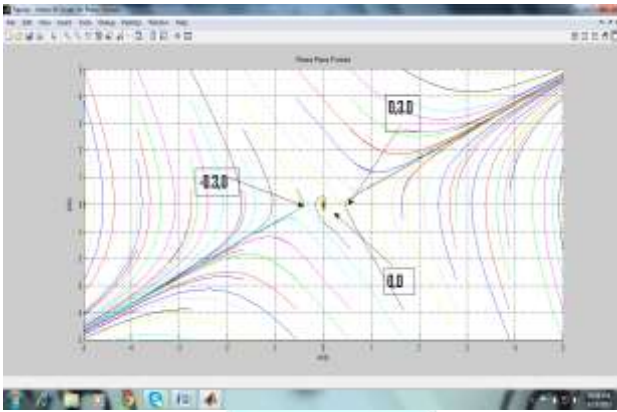

FigH2 : : PHASE PORTRAIT FOR CASE8

IV. OBSERVATION

- 1) It has been observed that phase portrait for case 1 is converging towards the origin i.e the trajectory is spiral curve converging towards the origin ,then the system is Stable Focus .It shows that the roots are complex conjugate with negative real part.It also shows one equilibrium point in figA2.
- 2) It has been observed that phase portrait for case 2 is converging towards the origin i.e the trajectory is spiral curve converging towards the origin ,then the system is Stable Focus .It shows that the roots are complex conjugate with negative real part. It also shows one equilibrium point in figB2.
- 3) It has been observed that phase portrait for case 3 is first converging towards origin and without touching it, diverges towards another side, i.e. the trajectory is saddle , then the system is inherently unstable .i.e. roots are real and negative of each other. In fig C2.
- 4) It has been observed that phase portrait for case 4 is of closed form about the origin ,then the system is Stable Focus .i.e the roots are complex in fig D2.
- 5) It has been observed that phase portrait for case 5 is first converging towards origin and without touching it, diverges towards another side, i.e. the trajectory is saddle , then the system is inherently unstable .i.e. roots are real and negative of each other.in fig E2.
- 6) It has been observed that phase portrait for case6 is converging towards the origin i.e the trajectory is

spiral curve converging towards the origin ,then the system is Stable Focus at (0,0) and saddle at two points. As shown in figF2.

- 7) It has been observed that phase portrait for case 7 is first converging towards origin and without touching it, diverges towards another side, i.e. the trajectory is saddle , then the system is inherently unstable .i.e. roots are real and negative of each other.in figG2
- 8) It has been observed that phase portrait for case 8 is converging towards origin and without touching it, diverges towards another side, i.e. the trajectory is saddle at two points, then the system is inherently unstable .i.e. roots are real and negative of each other and also one trajectory is converging towards origin ,therefore the system is stable focus as shown in figH2.

V. CONCLUSION

The analysis results of the linear system with non linearity has been attached above with their respective case .Each case comprise of linear system with non linearity such as saturation ,ideal relay ,ideal relay with dead zone, ideal relay with hysteresis. The obtained analysis result i.e. the phase portrait depend on the type of roots obtained which is mentioned on above in II section i.e. present work. In this paper the Phase Portrait of the Non linear system has been obtained ,and according to the trajectory the type of stability can be detected which in turn shows the types of roots the system possess. The detail of the output has been discussed in the in IV section .i.e .observation.

VI. REFERENCES

- [1] Proceeding of the 13th WSEAS International Conference on systems 'Simple Method for Stability Analysis of non-linear Control System'.
- [2] Advance Control System-M.Rihan.
- [3] Automatic control system-S.Hasan Saeed
- [4] Practical Stability Analysis of uncertain non linear systems
- [5] Solving Engineering System dynamics problems with MATLAB-Rao V.Dukkipati
- [6] Demos of Nelinsys Toolbox ofMATLAB.
- [7] CASE6 of this paper is solved Demo of nelinsys toolbox of MATLAB.